

HIGH RELIABILITY NETWORK AND DATA-HANDLING
TECHNOLOGY FOR DEMANDING APPLICATIONS

+ SpaceWire

+ SpaceFibre

STAR-Dundee is a world leading provider of spacecraft on-board data handling network technology for the aerospace industry

STAR-Dundee is an aerospace engineering company, which designs network and related data-handling technology for use on-board spacecraft. STAR-Dundee provides electronic test and development equipment and chip designs for spaceflight applications.

Our highly experienced engineers were instrumental in the development of SpaceWire, writing the ECSS standard with inputs from international spacecraft engineers. SpaceWire is now widely used on-board spacecraft with over 100 space missions already in orbit or currently being designed using SpaceWire technology. Our engineers have led the research, technical development and standardisation of the next generation of SpaceWire technology, SpaceFibre, which is a substantial leap forward, offering much higher data rates, quality of service, fault detection, isolation and recovery, deterministic data delivery, low latency time-synchronisation and event signalling, and many other features and benefits.

Since 2002, STAR-Dundee has provided SpaceWire evaluation, test and development equipment to the world's space agencies and aerospace companies. Our SpaceWire interface boards and units are used in Electronic Ground Support Equipment (EGSE) for integrating and testing many spacecraft. Our IP cores are integrated in spaceflight systems monitoring the Earth, exploring our Solar System, studying the universe and supporting commercial space applications.

STAR-Dundee is committed to providing the best possible solution for your application. Our team of highly qualified and experienced engineers understands the challenges of designing systems for space applications. Our well proven technology has flown on many high profile space missions. Part of our commitment to our customers is the effort that we spend on the research, development and standardisation of data-handling technology. SpaceFibre is the latest manifestation of our commitment to engineering excellence and international standardisation.

+ SpaceWire

SpaceWire is a data-handling network for use on-board spacecraft, which connects together instruments, mass-memory, processors, downlink telemetry, and other on-board sub-systems. SpaceWire is simple to implement and has some specific characteristics that help it support data-handling applications in space: high-speed, low-power, simplicity, relatively low implementation cost, and architectural flexibility making it ideal for many space missions. SpaceWire provides high-speed (2 Mbit/s to 200 Mbit/s), bi-directional, full-duplex data-links, which connect together SpaceWire enabled equipment. Data-handling networks can be built to suit particular applications using point-to-point data-links and routing switches.

Since the SpaceWire standard was published in January 2003, it has been adopted by ESA, NASA, JAXA and Roscosmos for many missions and is being widely used on scientific, Earth observation, commercial and other spacecraft. High-profile missions using SpaceWire include: Gaia, ExoMars Rover, BepiColombo, James Webb Space Telescope, GOES-R, Lunar Reconnaissance Orbiter and ASTRO-H.

+ SpaceWire aims to:

- Facilitate the construction of high-performance on-board data-handling systems
- Help reduce system integration costs
- Promote compatibility between data-handling equipment and subsystems
- Encourage re-use of data-handling equipment across several different missions

Use of the SpaceWire standard ensures that equipment is compatible at both the component and sub-system levels. Instruments, processing units, mass-memory devices and down-link telemetry systems using SpaceWire interfaces developed for one mission can be readily used on another mission. SpaceWire:

- Reduces the cost of development (cheaper)
- Reduces development timescales (faster)
- Improves reliability (better)
- Increases the amount of scientific work that can be achieved within a limited budget (more)

STAR-Dundee offers an extensive range of products to support the design, development, integration and testing of SpaceWire devices, equipment and systems

SpaceWire Interface Devices

STAR-Dundee provides several SpaceWire interface devices, each of which also includes a SpaceWire Router function so that routing concepts can be explored. Each device can act as a time-code master and also supports the injection of errors.

Comprehensive application programming interfaces (APIs) and extensive source code examples make it easy to develop applications to utilise the features of each device. Windows and Linux drivers are provided with each device, and other platforms are supported separately. STAR-System software provides a common interface across operating systems.



+ SpaceWire Brick Mk4

- Suitable for use in all stages of SpaceWire equipment development. It provides: two SpaceWire interfaces; support for high speed data transfer; the capability to inject various types of errors on demand; the ability to transmit and receive time-codes and act as a time-code master. It comes complete with highly optimised host software for low latency transmission of SpaceWire packets directly to and from the host PC.
- Expanding on the 15 years of knowledge and experience gained with the original SpaceWire-USB Brick, the Brick Mk2 and the Brick Mk3, the SpaceWire Brick Mk4 has enhanced FMECA protection. The use of STAR-Dundee's powerful software stack, STAR-System, makes it simple to migrate from the Brick Mk2 or Brick Mk3 to the Brick Mk4.

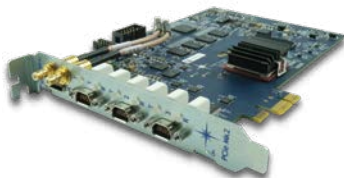

+ SpaceWire PCI Express (PCIe) Mk2

- Provides three SpaceWire interfaces with the PCIe bus and highly optimised host software offering low latency transmission of SpaceWire packets directly to and from the host PC.
- Two external SMB trigger interfaces are provided, which can be configured as input or output triggers.
- Suitable for all stages of SpaceWire equipment development from initial SpaceWire evaluation, instrument simulation, control system simulation, unit testing, integration support and EGSE.
- Backwards compatible with the SpaceWire PCIe (Mk1) functionality.



+ SpaceWire PXI Mk2 Interface Card

- A versatile SpaceWire Interface device. The card is designed to be an efficient host interface to a SpaceWire network by utilising a cPCI or PXI (PCI eXtensions for Instrumentation) backplane assembly.
- Utilises STAR-Dundee's efficient host software support for the rapid sending and receiving of SpaceWire packets straight into host PC memory.
- Suitable for use in all stages of SpaceWire equipment development including initial SpaceWire evaluation, instrument simulation, control system simulation, unit testing, integration support, and EGSE.
- Can be combined with STAR-Dundee's LabVIEW products to provide a powerful, yet easy to use, visual programming interface to a SpaceWire network.
- Available with optional Remote Memory Access Protocol (RMAP) Target, enabling the card to act as a remote RMAP target which can be configured through a powerful API.



+ SpaceWire PCI Mk2

- Provides three SpaceWire interfaces for low latency transmission and reception of packets and events over the PCI bus to and from the host PC.
- As with all STAR-Dundee interface devices, the PCI Mk2 is supplied with the STAR-System software suite. This includes a collection of graphical user interface applications which can be used to perform many common tasks, including injecting errors, configuring time-code generation and transmitting and receiving packets at high data rates. Also included are APIs, with thorough documentation and examples, which can be used to develop applications for performing very specific tasks.

SpaceWire Routers

A range of dedicated router devices are available, building on STAR-Dundee's experience developing the ESA radiation tolerant SpaceWire Router ASIC, the Atmel/Microchip AT7910E.



+ SpaceWire Router Mk2S

- Suitable for all stages of SpaceWire equipment development, it is functionally equivalent to the STAR-Dundee Router IP and the AT7910E, available from Atmel/Microchip.
- Provides eight SpaceWire interfaces and a USB interface which can optionally be used to connect the unit to a host PC. It has the ability to act as a time-code master, supports high speed data transfer and has the capability to inject various types of errors on demand.
- Expanding on the ten years of knowledge and experience gained with the original SpaceWire Router-USB and Router Mk2, this device has new features to enhance its capability and has been migrated to support STAR-Dundee's powerful software stack: STAR-System.



+ SpaceWire PXI Mk2 Router

- Incorporating STAR-Dundee's advanced SpaceWire routing technology, the SpaceWire PXI card is able to route packets between SpaceWire ports and the cPCI interface. Path and logical addressing are supported along with a router configuration port.
- The card is designed to be an efficient host interface to a SpaceWire network by utilising a cPCI or PXI (PCI eXtensions for Instrumentation) backplane assembly.
- The card provides support for high speed data transfer, the capability to inject various types of errors on demand, the ability act as a time-code master, and comes complete with highly optimised host software for low latency transmission of SpaceWire packets directly to and from the host PC.

SpaceWire Analysis Tools

STAR-Dundee analysis tools are designed to help find issues with SpaceWire systems and application hardware and software, rapidly and efficiently.

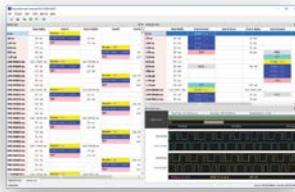

+ SpaceWire Link Analyser Mk3

- An essential tool when debugging an issue in a SpaceWire system. The Link Analyser Mk3 is a software and hardware solution for monitoring and recording the packets, characters and waveforms on a SpaceWire link.
- The device can be configured to trigger on various conditions including error events, data patterns or an external trigger. Significantly increased on-board memory allows up to 67 million events to be captured and displayed.
- Connected to a host PC using a high-speed USB 3.0 interface, traffic is quickly uploaded before it is displayed in a variety of new software views, from waveform to RMAP packets, including a high level network view used to identify trends and navigate traffic. Search facilities are provided to quickly locate areas of interest in the recorded data.



+ SpaceWire Recorder Mk2

- Unobtrusively record and view large quantities of traffic travelling over up to four SpaceWire links.
- Inserted inline on SpaceWire links of interest. When recording is started, packets, time-codes and link errors are written to solid-state disk along with their time information.
- Complete computer rack system. It consists of a cPCI chassis containing STAR-Dundee's SpaceWire Recorder board, a powerful CPU card with two solid-state disks, and a power supply.

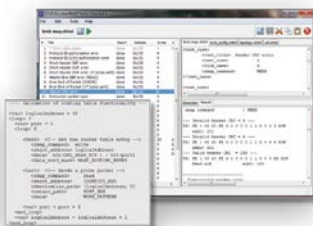

+ SpaceWire RMAP Tester

- A software test platform that validates SpaceWire RMAP target implementations and tests generic functionality of any unit that relies on the RMAP protocol for its configuration and control.
- Used in conjunction with a STAR-Dundee interface or router, for example the SpaceWire Brick Mk4, the tool gives an intuitive graphical user interface from which a list of predefined RMAP test descriptions can be selected to quickly verify that the unit under test complies with the RMAP standard.

Other SpaceWire Test and Development Equipment



+ SpaceWire Conformance Tester Mk2

- Provides a wide range of tests to probe the compliance of SpaceWire devices against the SpaceWire ECSS standard. It is supplied as a single instrument to support hardware and software engineers developing and using SpaceWire systems.
- Comprises a specially developed SpaceWire interface device and software running on a host PC.



+ SpaceWire Isolator

- Provides an inexpensive protective barrier between SpaceWire test equipment and valuable SpaceWire flight hardware. The Isolator protects equipment from electrical surges and transient voltage spikes, and eliminates ground loop currents flowing between equipment which can cause damage and poor equipment performance. It is very easy to use and operates transparently with no additional software drivers or configuration required.



+ SpaceWire EGSE and Device Simulator Mk2

- Emulates instruments or other SpaceWire equipment in real-time. The EGSE Mk2 is configured using a simple yet powerful scripting language that allows complex packet sequences to be transmitted with microsecond accuracy. Once configured, the EGSE Mk2 operates independent of software resulting in real-time performance that mimics the behaviour of SpaceWire equipment. This vastly reduces traditional development time, risk and cost associated with writing equivalent software in a real-time operating system.



+ SpaceWire Physical Layer Tester (SPLT)

- Determines the tolerance of a SpaceWire device to degraded Low Voltage Differential Signals (LVDS) by altering the output SpaceWire LVDS and exposing the received LVDS for measurement on an oscilloscope.
- Configurable parameters allow the amount of skew, swing and common mode voltage of the LVDS to be adjusted, either independently or collectively.
- Provides interfaces to a host PC, a high bandwidth oscilloscope and a logic analyser, which allows the SPLT to be connected in a variety of configurations to comprehensively test and explore the margins of the physical layer of a SpaceWire unit under test (UUT).





+ 19" Rack Mounting Kit Mk2

- A 19" Rack Mounting Kit is available to help organise STAR-Dundee SpaceWire and SpaceFibre development equipment in a rack.



+ Cabling

- STAR-Dundee's SpaceWire Lab Cables have been designed to be easy to use in the laboratory while giving similar performance to standard SpaceWire cables. The innovative connector assembly uses captive jackscrews, allowing the connector to be fully mated before the jackscrews are screwed home. This makes mating and de-mating the connectors much easier.

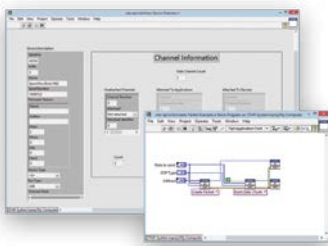

+ LabVIEW Support

- STAR-Dundee offers two products to access devices from the LabVIEW software development environment (a visual, dataflow programming language provided by National Instruments Corporation):
 - STAR-System for LabVIEW
 - Provides access to all the features of STAR-System, the common API for all new and future STAR-Dundee SpaceWire devices, from within LabVIEW for Windows.
 - Features include transmitting and receiving SpaceWire traffic, creating RMAP packets, and performing device configuration.
 - SpaceWire LabVIEW VISA Driver
 - A native LabVIEW driver which provides low level access to the STAR-Dundee PCI family of devices (cPCI, PCI, PCIe and PXI) on any hardware platform that supports NI-VISA.

Real-Time Operating System Support

STAR-Dundee's software suite, STAR-System, is also available for the VxWorks, QNX and RTEMS real-time operating systems. A version is also available from Concurrent for their RedHawk Linux real-time operating system.

These versions of STAR-System provide all the features present on Windows and Linux for accessing the STAR-Dundee PCI family of devices (cPCI, PCI, PCIe and PXI).

Please contact STAR-Dundee for information on currently supported platforms.

LEON Development Equipment

STAR-Dundee also provides development equipment and software for LEON based processors.



+ SpaceWire RTC Development Kit

- Designed to support the development of hardware and software based on the SpW-RTC Processor (Atmel AT7913E). The Development Kit consists of a development unit and a complete all-in-one software development environment (the SPARCv8-SDE). It provides great flexibility and supports a variety of test and development scenarios in a single instrument to help reduce development time and cost.

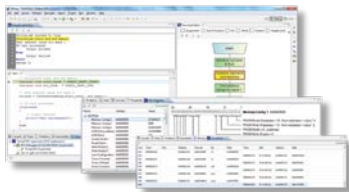

+ The SPARCv8 Software Development Environment (SPARCv8-SDE)

- Supports the development of software for the SPARC v8 series of processors, SoC devices and FPGA cores.
- Consists of an all-in-one software development environment that provides great flexibility allowing generic application software development and, through a library of plugins, processor specific software.
- As well as the standard features expected in a development environment, such as breakpoints, single stepping through code, etc., the SPARCv8-SDE has numerous features to ease debugging such as graphical views of individual registers, describing the meaning of individual bits.

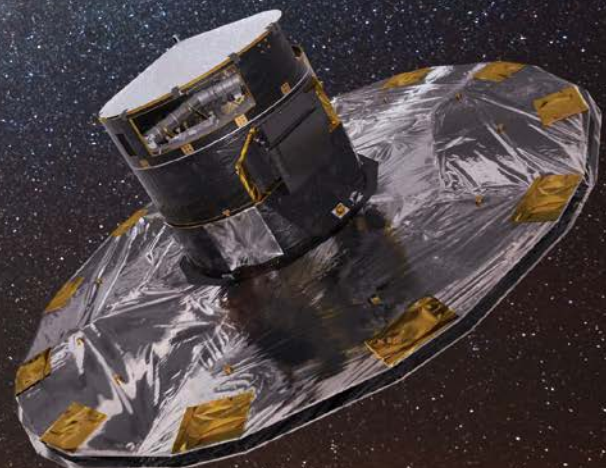

SpaceWire IP Cores

STAR-Dundee provides a range of well tested and widely used IP cores. Our IP products offer a cost effective and low risk solution for adopting SpaceWire technology for instruments, processors, memory systems and other on-board data handling equipment.

Our range of IP cores have been implemented in Xilinx, NanoXplore and Microchip FPGA and ASIC technologies.

+ SpaceWire Interface

- Provides a highly flexible interface to SpaceWire with the following features:
 - Fully compliant with the SpaceWire standard
 - Low power by design
 - Configurable clocking schemes to meet the requirements of a wide range of applications
 - Simple data interface based on input and output FIFOs
 - Simple time-code interface
 - Status and error reporting

+ SpaceWire Remote Memory Access Protocol (RMAP)

- Provides a standard mechanism for reading from, and writing to, memory in a remote SpaceWire node. This simple but powerful capability is designed into components such as the SpW-10X router and missions including BepiColombo and MMS. RMAP is an ECSS standard (ECSS-E-ST-50-52C).
- STAR-Dundee provides two independent SpaceWire RMAP IP Cores that together implement the RMAP standard:
 - SpaceWire RMAP Target IP core
 - SpaceWire RMAP Initiator IP core

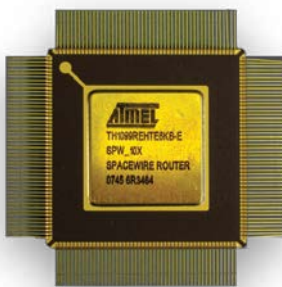

+ SpaceWire Router

- Permits the creation of a flexible wormhole router based on a non-blocking crossbar switch.
- Fully compliant with the SpaceWire standard with up to 31 SpaceWire ports, the device includes a number of features to configure the technology for maximum benefit.
- Configuration port which allows the device to be configured using RMAP.
- Designed into components such as the SpW-10X router.

+ SpaceFibre

SpaceFibre is a spacecraft on-board data-link and network technology developed by STAR-Dundee and the University of Dundee for ESA, with inputs from international spacecraft engineers. It runs over both electrical and fibre optic cables. It is the next generation of the widely used SpaceWire technology, offering higher throughput, lower mass and new capabilities including quality of service (QoS) and fault detection, isolation and recovery (FDIR). Initially targeted at very high data rate payloads such as Synthetic Aperture Radar (SAR) and multi-spectral imaging instruments, SpaceFibre is capable of fulfilling a wider set of spacecraft on-board communications applications because of its inbuilt QoS and FDIR capabilities and its backwards compatibility with the ubiquitous SpaceWire technology.

SpaceFibre provides high performance: 3.125 Gbit/s in Microchip RTG4 FPGAs and more than 6.25 Gbit/s in Microchip PolarFire and Xilinx Kintex UltraScale or Versal. Multi-laning can be used to achieve much higher data rates, e.g. 50 Gbit/s, sufficient for most, if not all, spacecraft on-board data-handling operations.

The SpaceFibre QoS mechanisms use virtual channels to provide multiple independent communication channels over a single physical link. Each channel provides priority, bandwidth reservation and scheduled QoS. These QoS mechanisms operate together, resulting in very versatile QoS which also provides scheduled, deterministic communication without wasting any network bandwidth.

SpaceFibre FDIR detects, isolates and recovers from faults in the link where they occur, which prevents faults from propagating and causing further errors. The FDIR capability of SpaceFibre provides galvanic isolation, transparent recovery from transient errors, error containment in virtual channels and frames, and “Babbling Node” protection.

Low latency broadcast messages are provided in SpaceFibre which enable the rapid signalling of events, reporting of errors, and distribution of system time information.

Very importantly, SpaceFibre is backwards compatible with existing SpaceWire equipment at the Network level allowing simple interconnection of existing SpaceWire devices into a SpaceFibre network and enabling that legacy equipment to take full advantage of the QoS and FDIR capabilities of SpaceFibre.

+ Benefits of SpaceFibre

SpaceFibre brings many benefits to spacecraft on-board data handling systems:

- Very high data rates that meet the needs of extremely demanding instruments, mass-memory internal networks, and telecommunications systems.
- Small footprint enabling implementation in existing radiation tolerant FPGAs such as the Microchip RTAX, RTG4 and PolarFire (RTPF500T) devices, and the Xilinx Virtex-5QV, Kintex UltraScale (XQRKU060) and Versal (XQRVC1902), with well proven IP cores available from STAR-Dundee.
- Reduction of harness mass by 33% and 50% when comparing the mass of a single SpaceWire cable to SpaceFibre electrical and fibre optic cables respectively, and by more than 90% when comparing per bit transferred.
- Simplification of redundancy through integration of several on-board communication functions into a single network, and through the carrying of the traffic of multiple SpaceWire links over a single SpaceFibre link.
- Increase in reliability by requiring one network rather than two or three to carry out the necessary on-board communication functions.
- Straightforward error recovery, since transient errors are recovered on the link and do not need to be considered at the system level.
- Deterministic data delivery enabling AOCS/GNC and other control applications to be supported.
- Long distance communication enabling launcher applications to be addressed, where a single network can provide control, monitoring and video capture functions.
- Galvanic isolation improving system robustness by preventing fault propagation.

SpaceFibre enables a single, integrated network to be used which carries instrument data, configuration and control information, deterministic traffic, high-resolution time information, and event signals. This improves reliability, saves mass, and reduces cost.

SpaceFibre Products

STAR-Dundee has an expanding range of SpaceFibre products available to support the evaluation, design, testing and deployment of SpaceFibre. Many additional products are currently under development.

SpaceFibre Devices

STAR-Dundee continues to expand its range of SpaceFibre devices, which already includes interfaces, routers, link analysers, and packet generators and checkers.

+ STAR Fire Mk3

The STAR Fire Mk3 is specifically designed to support SpaceFibre test and development. It operates in various modes: SpaceFibre interface, SpaceWire to SpaceFibre interface, SpaceFibre packet generator and checker and SpaceFibre link analyser. The unit has a USB 3.0 interface to a host computer, and software to support high data rate packet input/output between a host PC and SpaceFibre.

STAR Fire Mk3 Block Diagram, Photograph of Unit and STAR Fire Mk3 Software Screenshots

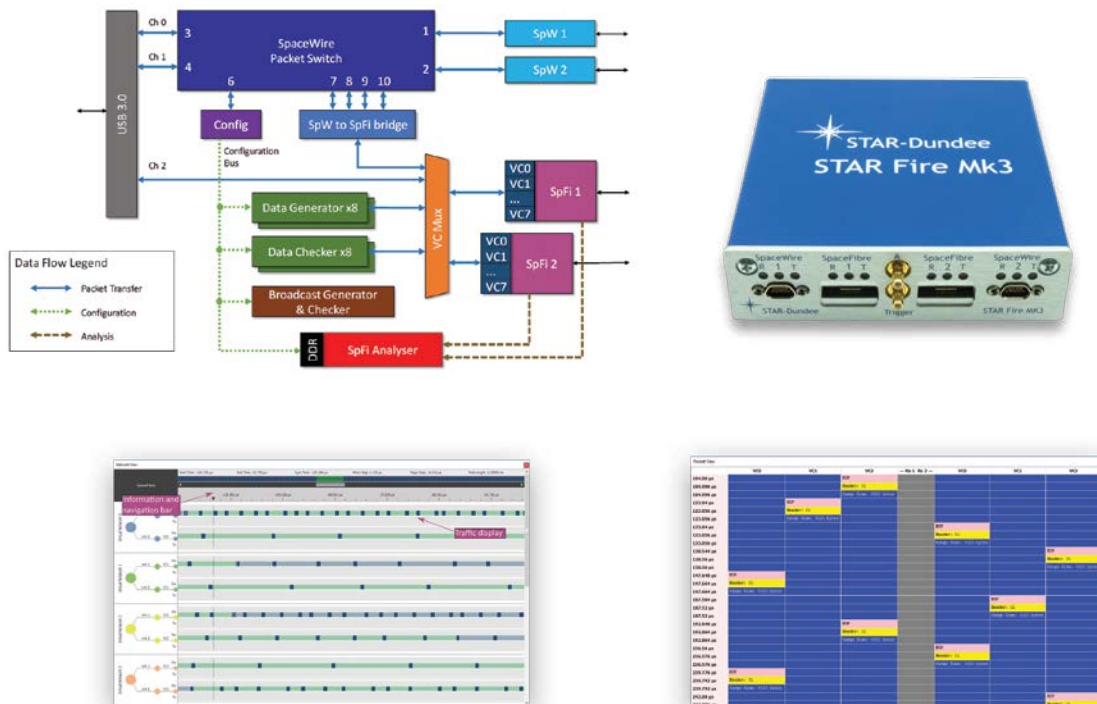

+ SpaceFibre Router and Interface Boards

STAR-Dundee has developed a versatile PXI board that has been used to implement a range of SpaceWire and SpaceFibre boards including the SUNRISE 8-port SpaceFibre Router, a 4-port SpaceFibre interface and a SpaceWire to SpaceFibre interface. This board has a novel set of front panel interconnects that enable the one base board to be used to implement many different products.

The STAR-Dundee SUNRISE SpaceFibre router provides eight SpaceFibre ports, each with four virtual channels, a ninth port which has four virtual channels each tied to a SpaceWire interface, and an internal configuration port. The router implements path and logical addressing, group adaptive routing, virtual networks, time distribution, and message broadcast. It fully supports the QoS and FDIR capabilities of SpaceFibre.

SUNRISE Router Block Diagram and Implementation on a STAR-Dundee PXI Board

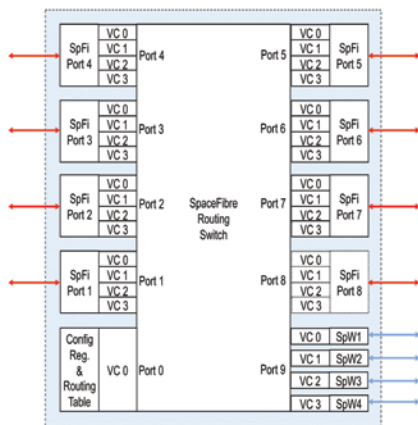

+ STAR-Ultra PCIe



The STAR-Ultra PCIe is a SpaceFibre Multi-Lane interface and link analyser, designed to aid test and development of SpaceFibre equipment. It can transmit and receive SpaceFibre traffic from a host PC at data rates in excess of 10 Gbit/s, and it can record and display SpaceFibre traffic transmitted and received on one SpaceFibre port.

Several new SpaceFibre products are currently under development.

Please contact STAR-Dundee for the latest information.

SpaceFibre IP Cores

The STAR-Dundee range of SpaceFibre IP cores is currently being implemented in spaceflight systems by our customers. The SpaceFibre IP cores have been tested in various ASIC and FPGA technologies including Microchip RTAX, RTG4 and PolarFire, and Xilinx Virtex 5, 7-series, Kintex UltraScale and Versal. Support for the NanoXplore BRAVE NG-Large and NG-Ultra will be available soon. All the IP cores are fully compliant with the SpaceFibre ECSS standard (ECSS-E-ST-50-11C).

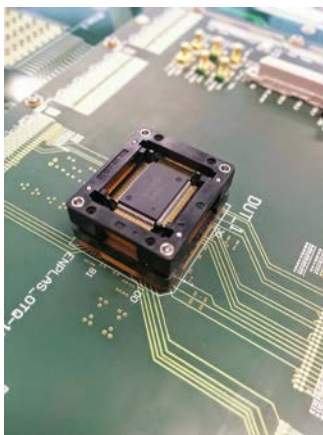

+ SpaceFibre Single-Lane Interface

- Provides a high performance SpaceFibre interface with the following features:
 - Small footprint: 2% of a Microchip RTG4 and 0.5% of a Xilinx KU060 FPGA
 - High performance: 3.125 Gbit/s in Microchip RTG4, and more than 6.25 Gbit/s in Xilinx KU060
 - Configurable number of virtual channels with independent QoS
 - AXI4-Stream application interface with independent data read and
 - Low latency broadcast message interface
 - Recovers from transient errors in less than 2 μ s without user intervention

+ SpaceFibre Multi-Lane Interface

- Use of multiple lanes provides higher data rate than a single lane interface, in addition to flexibility and redundancy:
 - Very high speed: e.g. with 4 lanes, 12.5 Gbit/s in Microchip RTG4 and 25 Gbit/s in Xilinx KU060
 - Configurable number of lanes
 - Small footprint: 8% of a Microchip RTG4 and 2% of a Xilinx KU060 FPGA for a 4-lane design
 - Hot and warm redundancy support with optional redundant lanes
 - Unidirectional lanes supported for mass and power saving
 - Graceful degradation in the event of a lane failure

+ SpaceFibre Router

- Provides a scalable, fully configurable non-blocking SpaceFibre routing switch which uses the same path and logical addressing capabilities as for SpaceWire, making SpaceFibre compatible with SpaceWire at the network level:
 - Configurable number and type of ports (SpaceFibre, SpaceWire or internal AXI4-Stream)
 - Configurable SpaceFibre lane rate, number of lanes, and number of virtual channels on each port
 - Internal configuration port (port 0) which uses RMAP for routing switch configuration
 - Supports path and logical addressing, group adaptive routing, virtual networks, full quality of service, fault detection, isolation and recovery, and low latency broadcast codes

Please contact STAR-Dundee for the latest information on the range of SpaceFibre IP cores.

Planet and Asteroid Natural scene Generation Utility (PANGU)

PANGU

PANGU is a powerful tool for modelling surfaces of planetary bodies such as Mars, the Moon, Mercury and asteroids using real and synthetic data.

Developed by the University of Dundee with support from ESA, PANGU offers a high degree of realism while operating at near real-time speeds on modern desktop PCs with graphics cards that support OpenGL 4.0 and programmable GPU shaders.

PANGU can combine real data such as Digital Elevation Models (DEMs) representing whole planets, higher-resolution DEMs of landing site regions and synthetic terrain to create multi-resolution models that can simulate the full descent of a planetary lander. Standard DEM projections are supported as are combining whole planet models with DEMs and atmosphere models. The ability to manage large models (i.e. greater than 64 GB) enables full lander descents to be simulated to a high degree of realism, with resolution varying from kilometres at the start of the descent to centimetres around the target landing site. Asteroids can be simulated by either importing shape models or by generating fully synthetic asteroid models.

The initial DEM can be obtained from instruments such as NASA's Lunar Reconnaissance Orbiter Laser Altimeter or ESA's High Resolution Stereo Camera. Alternatively, a DEM with user-defined roughness can be generated by PANGU using fractal techniques. Base DEMs can be interpolated with fractal detail to achieve a model resolution that is much higher than that of the original DEM. Realistic craters can be added using statistical models of properties such as age and diameter distribution; ageing factors ensure that the resulting craters match those observed in images of real terrain. Boulders and positive relief features can

be added to the surface controlled by various statistical distributions. For models of Mars, barchan dune fields can be modelled and craters can have flat bottoms as if filled by dust. An albedo/colour map can be applied for extra realism.

PANGU has the ability to generate camera, LIDAR and RADAR images from any position and orientation to support off-line and closed-loop simulations of planetary landing, surface roving and in-orbit rendezvous operations. The physics-based camera model includes features such as shot noise, thermal dark current, read-out noise, radiation events, photo-response non-uniformity and radial optical distortion. Pixel values can be represented at floating point precision or digitised to match ADCs with up to 16-bits. Integration with NAIF/SPICE allows images to be generated using publicly available historic and predicted data for planetary bodies and spacecraft, and the time of interest.

The practical applications of PANGU are as vast as the technology itself. From dynamic elements such as articulated rover vehicles to Martian scenes with movable dust devils, PANGU offers a realistic experience of bodies in our solar system.

PANGU v6 is now available, complete with a variety of model scenarios ranging from synthetic surfaces, asteroids and the Moon and Mars. The experienced team at STAR-Dundee holds a variety of case studies and imagery generated by PANGU, and can work with you to find the right solution for your mission.

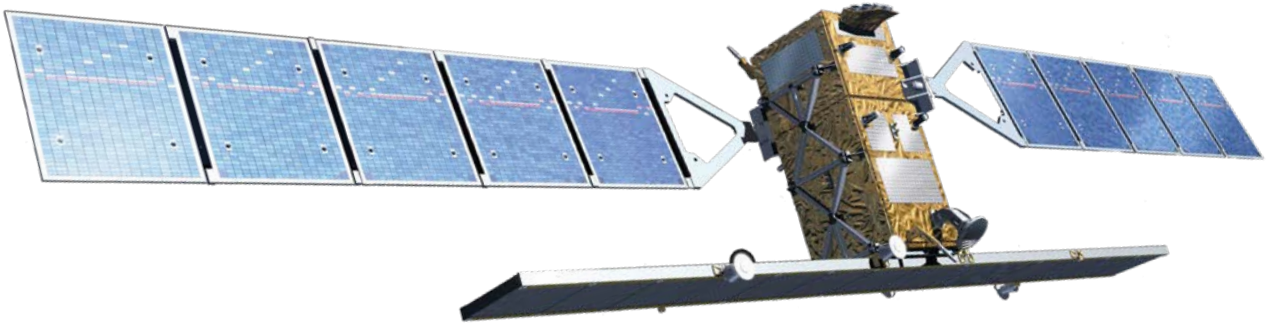

MICROCHIP

Microchip Partner

The radiation-hardened RTG4 and the radiation-tolerant RT PolarFire are Microchip's state-of-the-art space-qualified FPGAs, providing high density, high performance, embedded Maths Blocks, SpaceWire clock recovery circuits and embedded multi-Gbit/s SerDes. STAR-Dundee's range of SpaceWire and SpaceFibre IP cores has been customised and optimised for these two devices, providing the ultimate communication performance in a radiation tolerant FPGA.

STAR-Dundee has designed a range of products to support customers using SpaceWire and SpaceFibre technology on the RTG4 and RT PolarFire FPGAs.

<https://www.microsemi.com/product-directory/intellectual-property-partners/5186-star-dundee>

+ SpaceFibre and SpaceWire Applications

- The STAR-Dundee SpaceVPX-RTG4 interface board (currently under development and described on the following page) will be provided in the following forms:
 - SpaceWire router
 - SpaceWire to SpaceFibre interface
 - SpaceFibre interface
 - SpaceFibre router
 - Generic RTG4 3U cPCI/PXI development board with optional SpaceWire, SpaceFibre, CAN, USB-UART, UART, and other interfaces available on the front panel
- The STAR-Dundee PXIe-RTG4 interface board, described on the following page, can be provided in the following forms:
 - Generic payload processor board with SpaceWire and SpaceFibre interfaces
 - High speed DSP payload processor board with two multi Gsamples/s ADCs
 - FFT processor payload processor board

RTG4 Products

The STAR-Dundee boards incorporating the Microchip RTG4 are designed for two purposes: providing a high quality prototype for a range of SpaceWire and SpaceFibre applications for the RTG4 and providing a high quality engineering prototype board for the development of RTG4 applications.



+ PXle-RTG4 Board

- A 3U PXle board containing:
 - RTG4 PROTO silicon
 - Two banks of DDR memory
 - A PXle interface
 - A set of flexible interface connectors used for customising the board
 - A set of SpaceFibre IO connectors that can support up to eight SpaceFibre interfaces on the front panel
 - Various front panel options to support standard functions
 - Option for a custom front panel to support bespoke applications

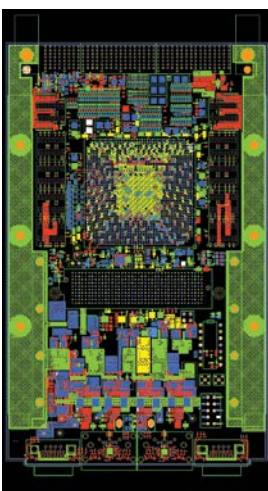

+ SpaceVPX-RTG4 Board

- A 3U SpaceVPX Lite board containing:
 - RTG4 PROTO silicon
 - Two banks of DDR memory
 - A SpaceVPX interface that supports a SpaceWire or SpaceFibre control plane and SpaceFibre data plane along with standard management functions
 - A pair of SpaceWire connectors on the front panel
 - A pair of SpaceFibre connectors on the front panel
 - An FMC type daughterboard connector with a dual 3 Gsamples/s ADC FMC board available for demanding DSP applications. Other daughter boards are planned.
 - Conduction cooled

Please contact STAR-Dundee for the latest information on the RTG4 products.

STAR-Dundee
STAR House, 166 Nethergate
Dundee DD1 4EE, Scotland, UK
Tel: +44 (0)1382 201755
Email: enquiries@star-dundee.com
Web: www.star-dundee.com
Twitter: @STAR_Dundee
LinkedIn: STAR-dundee

STAR-Dundee is an employee owned company
Spacecraft images courtesy of ESA



All information provided is believed to be accurate at time of publication. Please contact STAR-Dundee for the most recent details.

© 2022 STAR-Dundee Ltd